

SMOKE SCREEN



SENTINEL S55 v7 v1.2

INSTALLATION AND OPERATION

MANUAL

Revised Version: July 2022

Thank you for purchasing a Concept Smoke Screen system. Your choice to protect your property and premises with this equipment has given you the use of one of the most effective security systems currently available. Concept Smoke Screen systems have been in service for over 35 years and have protected many millions of pounds worth of property, defeating criminals and securing premises on an almost daily basis. We produce them because we believe you have a right to feel safe and secure.

Please take the time to read and understand this guide to ensure you achieve the maximum performance from your Smoke Screen. If you have any questions that remain unanswered, please call our experts at Concept Smoke Screen and we will help. Once again, thank you for your decision; we hope that it is one that never needs to be tested.

A handwritten signature in black ink, appearing to read "Matt Gilmartin", with a horizontal line underneath it.

Matt Gilmartin, Managing Director

CONTENTS

1	General	
1.1	Safety instructions	4
1.2	How does your Smoke Screen work?	4
1.3	Introduction	5
1.4	Overview	5
1.5	Typical installations	6
2	Location	
2.1	Positioning	7
2.2	Installation procedure	8
2.3	Servicing access	8
2.4	Mounting	8
2.5	Nozzle changing	9
3	Function	
3.1	Controlling the smoke	10
3.2	Outputs	11
4	Sentinel+	
4.1	Sentinel+ module installation, testing, and registration	12
5	Connections	
5.1	Circuit board layout	13
5.2	Connection Diagram: Using Smoke Screen Interface	14
5.3	Connection Diagram: Generic Alarm	15
6	Settings	
6.1	Screen sensor	16
6.2	Energy saving mode	16
6.3	Verification timer	16
6.4	Service mode	17
6.5	Inverting triggers	17
6.6	Tamper	17
6.7	Reboot	17
6.8	Fluid management	18
6.9	Battery management	20
6.10	Programming the Sentinel via LCD	21
6.11	Sentinel+ registration and remote configuration	23

7	Commissioning	
7.1	Operation	24
7.2	Testing	24
7.3	Sentinel+ testing remote monitoring.	25
8	Servicing	
8.1	Live Status	26
8.2	LCD, LED, and sound indications.	27
8.3	Thermal cut-out (TCO) reset	28
8.4	Action after every activation	29
8.5	Servicing and fluid replenishment	29
9	Miscellaneous	
9.1	Glossary	30
9.2	FAQ	31
9.3	End of product life policy	31
9.4	Warranty terms and conditions	32

1.1 SAFETY INSTRUCTIONS

Before installing and using the Smoke Screen read, follow, and retain this manual and safety instructions for future reference.

To reduce the risk of severe injury or death to persons, or damage to the Smoke Screen:

- Do not work on the Smoke Screen unless certified as competent by the manufacturer to do so.
- Disconnect the mains power supply before working in the heater block compartment or anywhere that mains voltage is indicated by the warning labels shown below (this is engraved with the layout of the PCB connections).
- Install in accordance with the instructions in this manual.
- Operate the Smoke Screen only from the type of power source indicated on the label.
- Do not modify the Smoke Screen.
- Adjust only the controls specified in this manual.
- Use only consumables and replacement parts specified by the manufacturer.
- Do not spill liquid of any type on, or inside, the Smoke Screen.

The following signs, or a variation, may be used for safety notices in this manual or on the Smoke Screen:



WARNING

This type of warning note is used to indicate possible electrical shock hazards that may cause serious injuries or death.



CAUTION

This type of warning note is used to indicate the possibility of injury caused by hazards other than electrical shock.

1.2 HOW DOES YOUR SMOKE SCREEN WORK?

Your Smoke Screen passes a non-toxic fluid through an efficient heat exchanger to create smoke, or more accurately a thermally generated fog that obscures visibility, discouraging intruders from entering your premises.

This fog is very persistent and will stay suspended in the room for a significant length of time until it is vented by opening the doors and windows. Venting should be performed within 2 hours of an activation.

The Smoke Screen uses a sophisticated electronic control system to ensure it heats up to, and maintains, its ideal operating temperature using a minimal amount of electricity.

The control system similarly provides a flexible interface with intruder detectors, alarm systems and remote monitoring centres to ensure that you are always protected and free of inadvertent activations.

1.3 INTRODUCTION

This manual covers the Sentinel S55 v7 v1.2, which can be upgraded to a Sentinel+ with the addition of an IP module. The manual also covers the S55 v6; however, this model cannot be upgraded to Sentinel+ without replacement parts and firmware upgrade. Some of the menu items listed are not available in earlier firmware.

Before commencing installation of the Smoke Screen ensure that you have all the following parts supplied in the box:

- 1 x Smoke Screen.
- 1 x Mounting bracket.
- 1 x Smoke fluid consumable.
- 2 x 12v batteries.
- 1 x Additional 30-degree Nozzle for wall mounted installation.
- 1 x Warning sign and documentation.

You will also need:

- Mains power supply: an unswitched 13 amp fused spur connected to a dedicated breaker.
- Connections into the alarm panel or other triggering system.
- PIR (or equivalent) to provide the hold-off where required.
- Ethernet connection if a Sentinel+ is being used.

1.4 OVERVIEW

The Smoke Screen is designed to form part of an existing intruder alarm system but may also be configured as a 'stand-alone' system or as part of a centrally monitored, command and control system. A typical installation is shown in the following schematic:

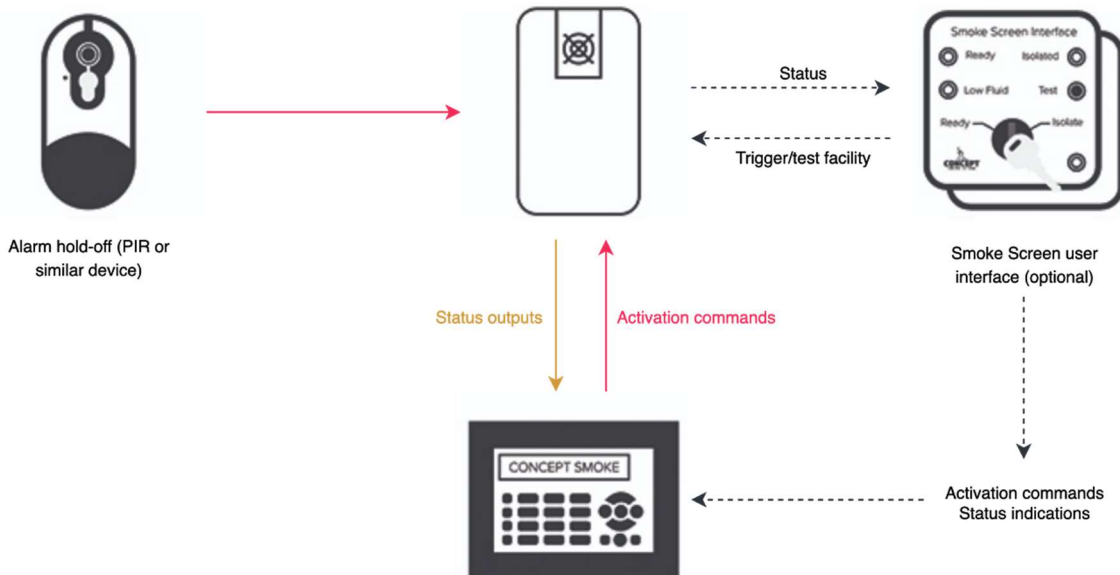

The optional Smoke Screen Interface allows easy connection to alarm systems, visual and audible status monitoring, the ability to isolate smoke system for alarm servicing, and simple activation testing of the smoke system.

1.5 TYPICAL INSTALLATIONS

Recommended installation configuration:

Smoke Screen is wall or ceiling mounted in the appropriate location.

Optional Smoke Screen Interface (SSI) usually fitted adjacent to alarm panel.

A Set command supplied by an alarm control panel, or equivalent, in the form of a Normally Closed (N/C) clean contact relay changing 'Energised Open' when the alarm system is set for operation.

An Alarm command supplied by the alarm control panel, or equivalent, in the form of a Normally Closed (N/C) clean contact relay changing 'Energised Open' when the alarm system detects an intruder. This can be a First Intruder or Confirmed as required.

Optional - A Hold-off PIR (or similar device) located within the same area as the Smoke Screen providing a confirmation signal to the Smoke Screen to start, or restart, 'smoke' production.

Optional - A Panic command in the form of a Normally Closed (N/C) relay or equivalent clean contact such as a dedicated panic button, that is opened when an instant activation is required.

Optional – Ethernet connection for Sentinel+ monitoring if fitted and required. Specifically for remote monitoring an Outbound TCP connection on port 8883 is required.

2.1 POSITIONING

The Smoke Screen should ideally be sited in a covert position away from prying eyes and thereby reducing the possibility of tamper or an attack. The ideal place for the Smoke Screen is above a ceiling from where the smoke plume is used to its best effect, bursting on the ground, and spreading outwards and upwards through 360°. If no suitable ceiling location is available, then the next best location is a wall mounting.

Wall-mounting

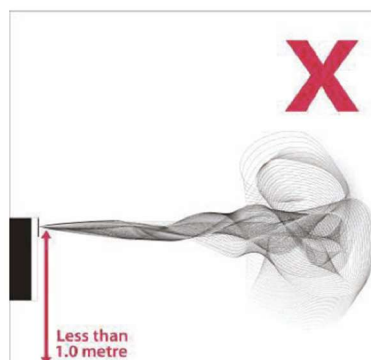
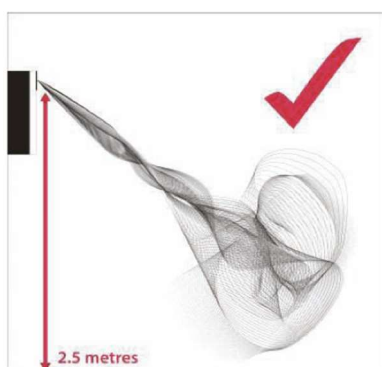

The optimum wall mounting position for the Smoke Screen is 2.5 metres above the floor facing the area to be protected and using the 30-degree angle nozzle. The maximum recommended mounting-height above floor level is 3 metres, the minimum is 1 metre and there should be no obstacle within 1 metre of the smoke output nozzle. Also, leave a minimum of 150mm clearance to the ceiling.

Ceiling-mounting

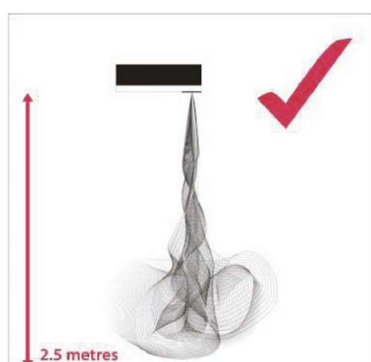

The optimum ceiling mounting position for the Smoke Screen is 2.5 metres above the floor facing the area to be protected and using the standard straight nozzle. The maximum recommended mounting-height above floor level is 3 metres, the minimum is 1 metre and there should be no obstacle within 1 metre of the smoke output nozzle.

2.2 INSTALLATION PROCEDURE

1. Site the Smoke Screen and fix to the wall or ceiling as appropriate.
2. Make connections as required to the alarm panel, SSI, hold-off PIR, and PA.
3. Fit batteries, do not switch on yet.
4. If fitted, set the Smoke Screen Interface to 'isolate'.
5. Select the '**Service Mode**' dip switch to '**On**'.
6. Change nozzle, if required, before powering up.
7. Connect and turn on the mains power.
8. Turn on the internal battery back-up switch.
9. The Smoke Screen will heat up to operating temperature in approximately 10-15 minutes.
10. Set correct time/date.
11. Set correct smoke timing for the specified room size.
12. if using a Sentinel+, connect an ethernet cable to the module and follow setup instructions.
13. Insert a fluid consumable.
14. Visually test all signals between the Smoke Screen, alarm panel, SSI, hold-off PIR, and PA (as fitted).
15. Confirm alarm panel has full control of the Smoke Screen. With SSI in 'Ready' position if fitted.
16. Ensure the '**Service Mode**' dip switch is selected to '**Off**'.
17. Make sure all tamper switches are closed.
18. Perform activation test.
19. Final check of settings and monitored signals, SSI in 'Ready' position if fitted.

2.3 ACCESS

To access the PCB connections, programming panel, mounting holes, batteries, and fluid, remove the front cover by unscrewing the set screws on either side and unhooking it from the back plate; refitting is the reverse process. Installation cable entry is through the serrated grommet on the left side of the back plate.

2.4 MOUNTING

The Smoke Screen can be mounted on a ceiling or a wall using the simple standard bracket supplied with the unit. This flush-fitting bracket maximizes security by concealing all the mounting fastenings such that they can only be accessed, or the Smoke Screen dismantled, by dismantling the unit. Moreover, the Smoke Screen has a tamper protection switch to provide an alert in the unlikely event that it is disturbed. In all cases, the installer must attach the Smoke Screen to the building structure using appropriate fasteners.

NB: When mounting the Smoke Screen ensure that the airflow through the vent holes in the rear of the unit is not obstructed.

Wall and ceiling mounting

Ceiling or wall mounting is the same process except that rather than fixing the Smoke Screen direct to a ceiling an intermediate unistrut section may be used or it can be suspended as described in the next section.

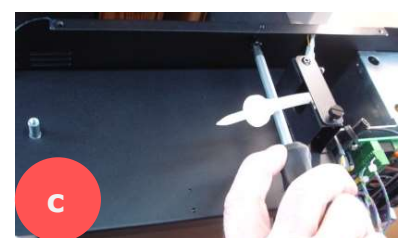

Suspension mounting

Suspending the Smoke Screen is achieved using a 'Suspension Kit' comprising a length of unistrut, two sections of threaded bar and fixings.

Suspension Kit Contents (all M8)

Unistrut 1 x 1 metre
Threaded bar 2 x 1 metre
1 x ceiling hole surround
2 x drop-in anchors
6 x full nuts
4 x 25mm washers
2 x 38mm washers
2 x channel nuts



Prepare the Smoke Screen by fitting the angle brackets. Fix the required length of M8 threaded bar to the bracket using 4 x nuts and 4 x 25mm washers.

Fix the unistrut into place. There are a range of fixings to accommodate concrete ceiling, girders etc. if in doubt contact the fixing supplier.



Attach the threaded bar to the unistrut using the channel nuts, 38mm washers and M8 nuts. Once this is done the Smoke Screen can be lifted into position and the set screws tightened as above.

Any fine adjustments can be made at this stage as the nuts and the threaded bar will take the weight of the Smoke Screen.



Any hole made in the ceiling below can be made good with a cosmetic hole surround.

Note: Final machine position should allow an air gap ~50mm above ceiling tile or when ducting.

2.5 NOZZLE CHANGING

To change the nozzle, first remove the front cover then remove and replace the nozzle using a 10mm ring spanner, sealing it with PTFE tape and ensuring that an angled nozzle is seated in the correct orientation. The Smoke Screen is delivered with a single-hole straight nozzle plus an extra 1-hole 30° angle down nozzle. The following are also available – 2-hole horizontal, 3-hole horizontal, 1-hole 30° angle down and 2-hole 30° angle down.



WARNING

Be aware of high voltage in the block area. The electrical supply should be switched off before working in the heater block compartment.



CAUTION

This operation is usually carried out during installation. If the Smoke Screen has been in service, the nozzles will be extremely hot and will cause injury if touched. Therefore, the Smoke Screen should be switched off and time should be allowed for the nozzles to cool.

3.1 CONTROLLING THE SMOKE

Alarm Panel activation

There are 3 sets of inputs on the Smoke Screen (Set, Alarm and Hold-off) that can be connected to clean contacts.

By default, for the Smoke Screen to produce 'smoke' all 3 sets of connections must be 'open circuit'.

We recommend using the default setting 'Normally Closed' to ensure that the Smoke Screen will activate in case the alarm cables are tampered from the outside. These settings can be reversed – see Section 6.5 Inverting Triggers.

- Set – a normally closed relay connected across the alarm panel 'Set' output connections, which is open when the alarm panel is 'Set' and closed when the panel is 'Unset'.
- Alarm – a normally closed relay connected across the alarm panel 'Intruder' output connections, which is open when the alarm panel or controlling device is in 'Alarm'.
- Optional - Hold-off – usually a PIR / movement sensor normally closed output, which opens when the sensor detects movement, connected to the Smoke Screen 'Hold-off' normally closed connections.
- Additional hold-off – any form of normally closed relay / micro switch / keyswitch can be connected to the 'Hold-off' connections. If fitted in parallel to a PIR both devices must be 'open' to produce 'smoke'.

NB: If no 'hold-off' is fitted the terminals should be left without anything connected and will show 'HO' on the display as in an active condition.

If a 'Panic' output from the alarm system is required to trigger the Smoke Screen we recommend using a DPDT relay connected to break the Set and Alarm Inputs to the SSI – This allows isolation of the Smoke Screen when testing the alarm system.

Optional Panic input activation

NB: The Panic trigger mode is delivered set to n/o and the Panic Smoke Time is set to 0 seconds to prevent inadvertent activation if the facility is not used. 'Panic Smoke Time' can be individually set.

The Smoke Screen has a Panic input that can be connected to a clean contact going 'open circuit' to activate (this can be changed to 'closed = activate' – see 'Invert Trigger Mode' in the Programming section).

It is recommended that the Panic is activated by a momentary, non-latching, button to avoid the situation where a Panic activation is not reset before a standard activation is required.

WARNINGS:

- **Service Mode should be selected to on if the Panic trigger mode is changed when the Smoke Screen is at operating temperature.**
- **Always restore a Panic input after it has been used. Failure to do so will result in the Smoke Screen not subsequently activating on an Alarm Panel (Set, Alarm and Hold-off) demand.**

Setting 'Smoke Time' and 'Panic Smoke Time'

The Smoke Screen 'Smoke Time' should be set to produce fog for a time that is suitable for the volume of the location to be protected. As a guide, an S55 set to 60 seconds Smoke Time will reduce the visibility to 1 metre* in a 200 m³ volume room. (*EN50131-8 Definition)

The Smoke Screen 'Panic Smoke Time' can either be set as a maximum to the same value as above or be used to give a shorter activation on demand if using a self-resetting PA button for example.

The Smoke Times are changed in the settings menu; see Section 6.10 - Programming

Hold-off settling time – 'Settle Timer'

A 'Settle Timer' can be programmed for a period between 0 and 60 seconds (in 1 second intervals) during which the Smoke Screen will not react to a hold-off input after receiving a 'Set' and 'Alarm' command.

Delaying an activation – 'Smoke Delay'

After the Smoke Screen has received the required 3 inputs to produce smoke, an activation can be delayed for a period between 0 and 60 seconds (in 1 second intervals). This can be used to sequence activations in a multi-machine installation. See 'Smoke Delay' in section 6.10 - Programming

NB: The Delay Timer and Settle Timer are cumulative, i.e., if a Delay Time of 5 seconds and a Settle Timer of 30 seconds are set: The Smoke Screen will not respond to the 'Hold Off' input for 30 seconds after it receives a 'Set' and 'Alarm' input, it will then delay a further 5 seconds from receiving a 'Hold-Off' input before making smoke.

Re-triggering option

If a Smoke Delay time has been set the menu gives the option to select the following options for subsequent re-triggers initiated by a hold-off if the Set and Alarm remain in alarm: See 'Retrigger' in section 6.10 - Programming

- **Delay:** Repeat activations are delayed by the Delay Time set.
- **Instant:** Repeat activations are instantaneous.

Stopping an activation

Once activated the Smoke Screen will stop producing 'smoke' before the end of the programmed smoke time only if the 'Set' is restored to a non-alarm state.

A Panic activation can only be stopped before the end of the programmed smoke time if the 'Set' is cycled to active and back to restore. This can be performed using the SSI Test Mode.

Preventing an activation

To prevent the Smoke Screen from making smoke during a service inspection under any circumstances select the 'Service Mode' dip switch to on (see separate section). **NB: Ensure switched off on completion.**

3.2 OUTPUTS

Clean contact outputs are provided for connection to the alarm panel for the following:

Mains Fault – Temperature Fault - Fluid Low - Fluid Empty - Battery Fault – Tamper - Verification Output.

A transistorised Set output is also available – 0V when set.

See the notes on the Connection Diagram for the function of these outputs.

Installing the Sentinel+ module

Follow the procedure below if the Sentinel+ module is not fitted on delivery.

- Remove the front cover.
- Switch off the batteries.
- Disconnect the mains power supply.
- Fit the Sentinel+ module to the female header sockets on the LCD PCB in the position shown below ensuring that the pins locate correctly, i.e., the pins line up starting from the left.

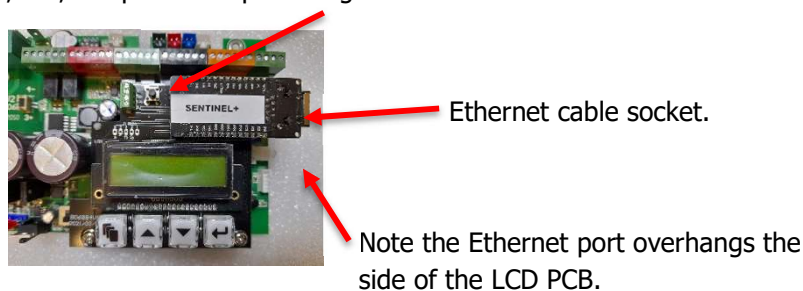

- Connect ethernet cable.
- Switch on the batteries and reconnect the mains power supply.

NB: Installing a Sentinel+ module with power applied to the Smoke Screen may cause the LCD display to corrupt – pressing the Function menu button should return the display to normal operation.

Setting up the Sentinel+

See Section 6.10 for information on programming and then make the following entries as required:

By default, the Sentinel+ IP address is set to 0.0.0.0 – This will use DHCP to attempt register onto the network, if successful the assigned IP address for the unit will be visible under the 'Telemetry' setting of LCD display menu.

If a static IP is required, you must manually enter IP address and subnet mask. You may also need to configure a default gateway address and a DNS server address. If you are unsure what settings to use then contact your Network Administrator.

NOTE: When making changes to the network settings, once all values have been entered - enter the 'Send Special Command Codes' menu select 'Send Command 1' then 'Enter'

In a browser enter the IP address, for example: <http://192.168.16.84/>

The Sentinel+ test page will be shown on the browser.

The Sentinel+ can now be registered for online monitoring. See Section 7.3

The Sentinel can now be remotely programmed if required. See Section 6.11

A simplified device monitoring page is available, for example: <http://192.168.16.84/status>

Sentinel+ self test	
Click here to register this device	
Filesystem Free Space	1376256 (66%)
Boot Time	2022-05-24T07:17:47
Firmware Date	2022-05-23
Subnet Mask	255.255.255.0
Current Time	2022-05-24T08:44:27
DNS Server	192.168.16.4
Device ID	a8032aa13b98
Allocated Memory	63840
Filesystem Size	2097152
Firmware Version	5.2.0a1
IP Address	192.168.16.84
Free Memory	47328 (43%)
MAC address	a8032aa13b9b
Default Gateway	192.168.16.1

Connections

5

5.1 CIRCUIT BOARD LAYOUT

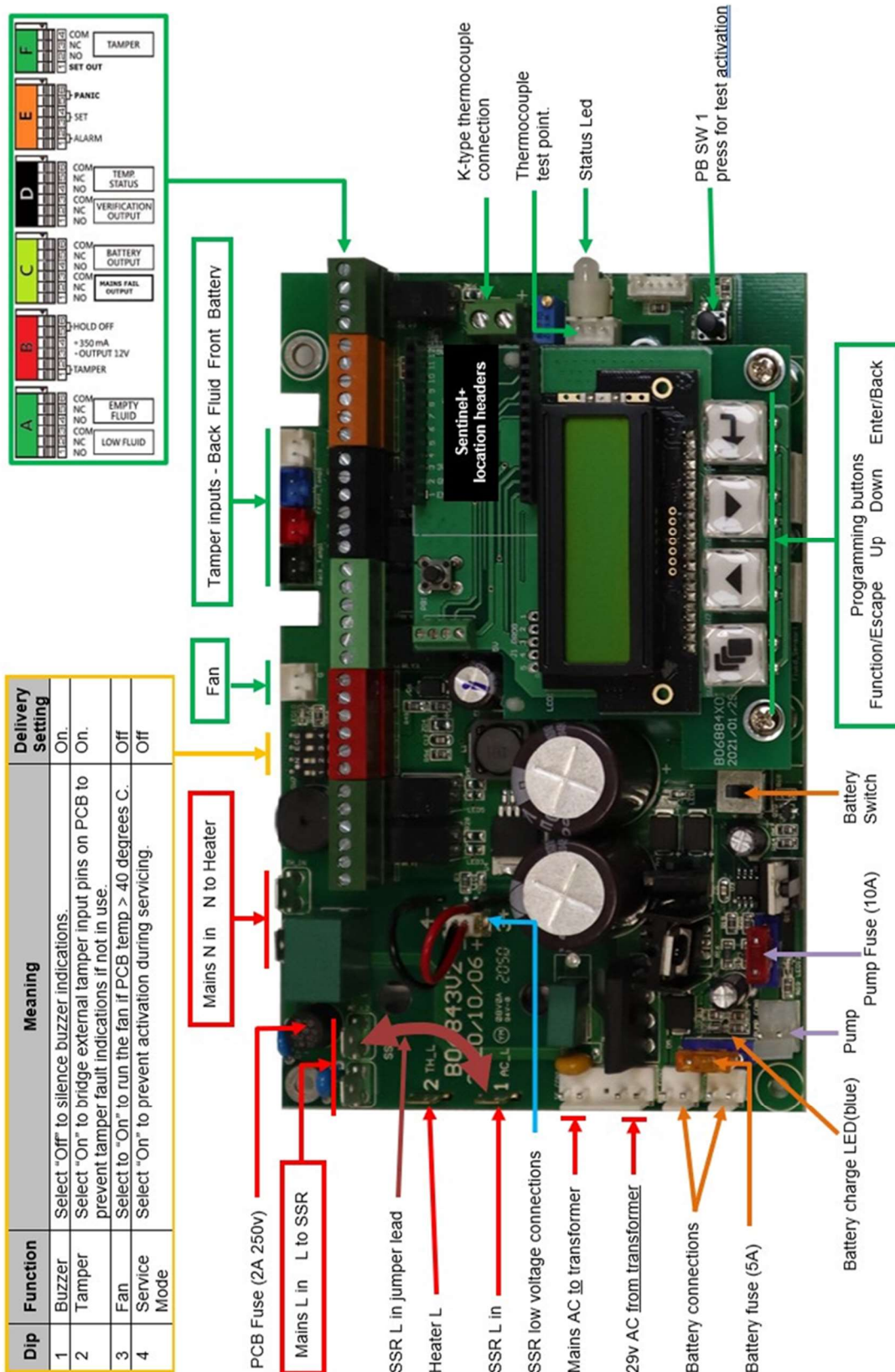

5.2 CONNECTION DIAGRAM USING SMOKE SCREEN INTERFACE (Recommended)

Sentinel v6, PIR, IAS and full function SSI Mk2 connection schematic

Alarm Panel Input Zone

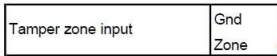

Example shown above for available monitoring outputs:

Tamper, Verification, Battery Fail, Mains Fail,

SSI

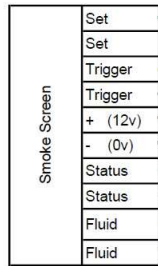

Sentinel

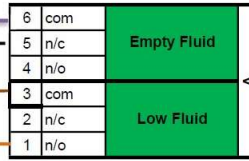
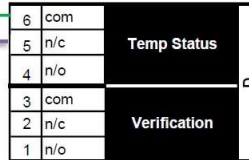

Function

"Tamper" changes state if the Sentinel case is open or if the Smoke Screen is in "Service Mode". n/c and n/o shown are when the case is closed and "Service Mode" is off.
Outputs 12v when "Set" input in Alert.

"Panic" should be connected to a normally closed* clean contact going open to fire the Sentinel. Only cycling the "Set" to "alert" then "Restore" will stop an activation

"Set", "Alarm" and "Hold Off" should be connected to normally closed* clean contacts going open to fire the Sentinel. All 3 must be open to activate the Sentinel*. Only closing* the "Set" will stop an activation.

"Temp Status" changes state if the Sentinel block is below operating temperature. n/c and n/o shown are when the Sentinel is at operating temperature.

"Verification" changes state when the Sentinel fires. n/c and n/o shown are when the Sentinel is not firing.

"Battery" changes state if there is a battery fault. n/c and n/o shown are when the battery is working correctly.

"Mains Fail Output" changes state if the mains power supply to the Sentinel fails. n/c and n/o shown are when the mains power supply is ok.

See note for Set* and "Alarm". Leave open if no device fitted*.

DC output for additional device. Total Sentinel output must not be greater than 350mA.

Loop tamper pins or select Dip 2 to "On" if not connected to a device.

"Empty Fluid" changes state if the Sentinel fluid is empty. n/c and n/o shown are when there is fluid available.

"Low Fluid" changes state if the Sentinel fluid is low. n/c and n/o shown are when the fluid level is greater than approximately 50% remaining.

Notes

This system enables the SSI "Test" facility to activate the Smoke Screen, as long as any hold-off is opened, irrespective of the Alarm Panel state.

This schematic shows the relevant pin connections, not specific cable runs. Installers should select appropriate 8 or 12 core cable and strand colours to suit the specific situation.

The SSI is shown as the 3 separate terminal sets.

Alarm Panel outputs contacts should be clean relay closed pairs energising open on set / intruder.

To simplify this schematic the connection pins may not necessarily be shown in the same order as the relevant unit.

The Smoke Screen Tamper output connection to an Alarm Panel is shown for example; other outputs can be connected in a similar way.

Alarm Panel Output Relays

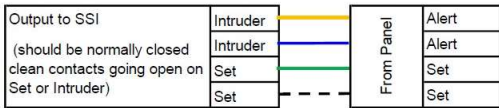

Alarm Panel Input Zones

Recommended monitoring

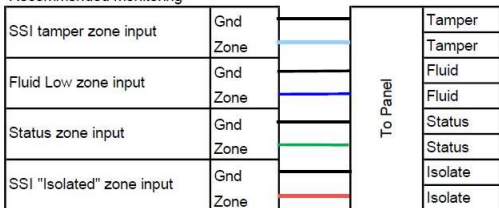

PIR



* unless Inverted Trigger mode is selected.

5.3 CONNECTION DIAGRAM GENERIC

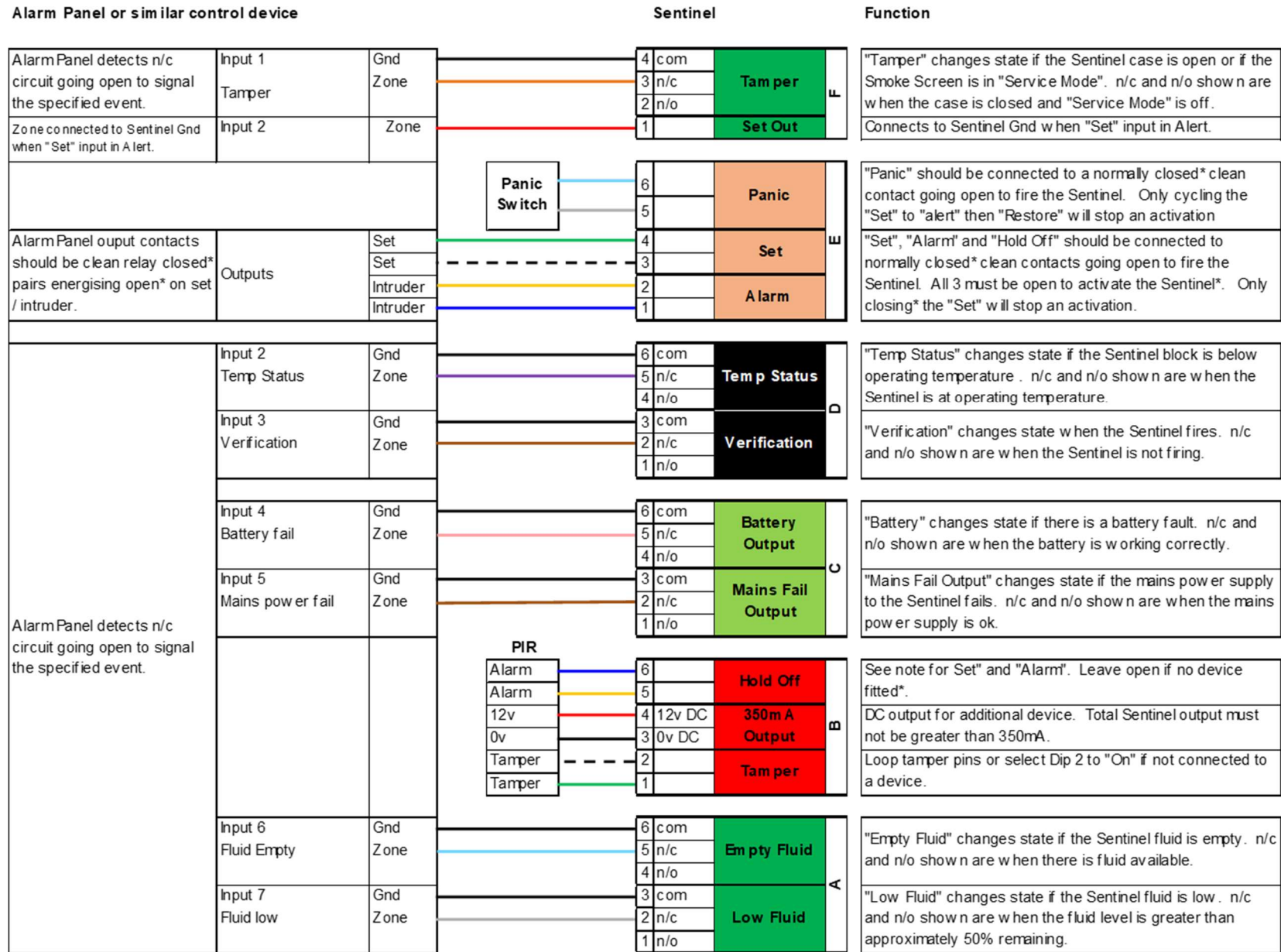

6.1 SCREEN SENSOR

A Concept Smoke Screen '*Screen Sensor*' can be connected to the Sentinel. When this is integrated the system detects a drop in the fog density in the protected area and will re-trigger the Sentinel to maintain the fog level. When fitted the *Screen Sensor* is connected to the Hold Off input pins and, consequently, it prevents the use of a hold-off detector.

NB: It is critical that the *Screen Sensor* is installed in an area that receives the maximum fog coverage. It will not operate correctly if this is not achieved

6.2 ENERGY SAVING MODE (ESM)

The Smoke Screen has 3 options for ESM:

- **ESM Disable.** The Smoke Screen maintains its normal running temperature.
- **ESM.** When ESM is selected and the alarm panel input to the Smoke Screen is 'Unset' the Smoke Screen lowers its running temperature to a standby level to reduce power consumption and cost. When the Smoke Screen receives an 'Alarm Set' input it automatically heats to its normal operating temperature.

NB: If the Smoke Screen is in ESM mode and is activated as soon as the alarm is set, i.e., before it has heated to normal operating temperature, it will still produce smoke but the length of time of the initial burst of fog will be shortened.

- **Extreme.** When Extreme is selected and the alarm panel input to the Smoke Screen is 'Unset' the Smoke Screen heater is not operated, and its temperature reduces to ambient. When the Smoke Screen receives a 'Set' input it automatically heats to its normal operating temperature.

NB: This will introduce a period where the Smoke Screen cannot produce fog as it heats up, this will also report a Temperature Fault (Not Ready) during the heating period.

WARNING: ESM should be disabled if the Smoke Screen is being used with a Panic input.

6.3 VERIFICATION TIMER

If the 'Verify Timer' is set to 0 seconds the verification output changes state during an activation for the set 'Smoke Time'. If the 'Verify Timer' is set above the set Smoke Time, the verification output maintains the changed state for that time after an activation starts.

NB: The Live Status verification display (V) is shown only during the production of fog, not for any subsequent time set by the 'Verify Timer'.

6.4 SERVICE MODE

Setting dip switch No 4 (see diagram under 'Circuit Board Layout') to 'On' puts the Smoke Screen into 'Service Mode'. This setting prevents the Smoke Screen from making smoke whilst work is conducted with power applied. To highlight that the Smoke Screen is in 'Service Mode' the Tamper output is put into an alarm state.

FAILURE TO DISABLE SERVICE MODE WHEN NO LONGER REQUIRED WILL PREVENT THE SMOKE SCREEN OPERATING.

6.5 INVERTING TRIGGERS

The Smoke Screen triggers, Set, Alarm, Hold-off and Panic should be connected to clean contacts changing state in alarm. The triggers can be set to normally closed (N/C) 'open = activate' or normally open (N/O) 'closed = activate'. We recommend using the default setting 'N/C' to ensure that the Smoke Screen will activate in case the alarm cables are tampered from the outside.

The Smoke Screen is delivered with the Set, Alarm and Hold-off triggers set to n/c, i.e., 'open = activate'. The Panic trigger is set to n/o to avoid an inadvertent activation if the facility is not used, and the Panic input is left open.

6.6 TAMPER

There are internal tamper circuits on all the Smoke Screen covers and an external tamper input on PCB terminal block 'B'. A 'Tamper Status' output is provided on PCB terminal block 'F'. To prevent unwanted tamper signals the external tamper input can be disabled if not in use by selecting dip switch 2 to 'On', which bridges the input pins on the PCB.

NB: A tamper 'open' state provides only an indication of the event; it does not automatically activate the Smoke Screen or prevent it from activation.

NB: Tamper output will also be active when 'Service Mode' is enabled.

6.7 REBOOT

When the Smoke Screen is in Service Mode the Reboot menu item becomes available. The Smoke Screen can be rebooted without removing mains and battery power by selecting 'Yes'. Any settings entered in the menu will be retained. This facility can be used to clear any critical faults.

6.8 FLUID MANAGEMENT

The Smoke Screen has a replaceable 1 litre Swift-Fit fluid reservoir (also known as product code SFL-1000) that is accessed by removing the cover on the right-hand side of the unit. The fluid level is monitored using sensors in the fluid reservoir to give a "Low Fluid" indication output when the Swift-Fit is approximately 50% full and an "Empty Fluid" output when the bottle is empty. The Smoke Screen will not produce fog when there is an "Empty Fluid" indication.



WARNING

Be aware of high voltage in the Smoke Screen. The mains electrical supply should be switched off before changing the fluid consumable.



CAUTION

If the generator has been in service, the heater block and connected parts will be extremely hot and will cause injury if touched. Switch off and allow the heater block to cool.

Changing a fluid consumable

Obtain a replacement fluid reservoir from your Smoke Screen supplier. Open the right-hand access panel. Lift the reservoir out of the compartment by removing the upper end first.

Disconnect the fluid monitoring cable.

Disconnect the fluid feed pipe (pull collar to release).

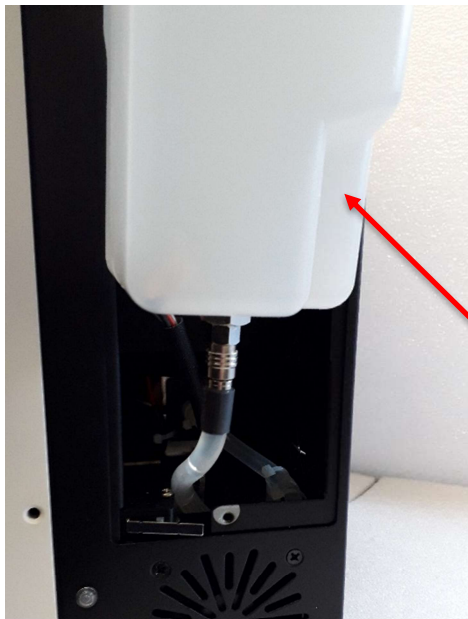
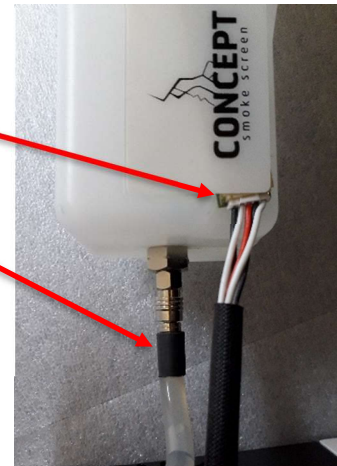

Connect the monitoring cable and feed pipe to a new fluid reservoir.

Insert the reservoir into the fluid compartment base first ensuring that the pipe connection is not accidentally released.

Make sure the notch in the reservoir is on the outside of the Smoke Screen or the compartment door will not fit. This orientation ensures that the fluid feed is correct for both upright and face-down installations.

WARNINGS:

WHEN A NEW FLUID CONSUMABLE IS FITTED BATTERY POWER MUST BE APPLIED TO THE SMOKE SCREEN TO RESET THE ESTIMATED FLUID REMAINING. THE SWIFT FIT HAS ITS OWN BUILT IN FLUID SENSOR THAT TAKES PRIORITY.

THE SMOKE SCREEN WILL NOT PRODUCE FOG IF THE CONSUMABLE IS NOT CORRECTLY FITTED.

INSERT FLUID CONSUMABLE WITH CARE: - THE QUICKFIT CONNECTOR CAN BE ACCIDENTALLY DETACHED OR FLUID LINE KINKED RESULTING IN REDUCED PERFORMANCE.

A SHORT TEST FIRE SHOULD BE PERFORMED AFTER A NEW FLUID CONSUMABLE IS FITTED

External reservoir

A 5000ml external reservoir can be used with Smoke Screen, please contact Concept Smoke Screen if you wish to use this function.

6.9 BATTERY MANAGEMENT

Operation

The Smoke Screen is fitted with a battery to provide power to the electronic circuits and pump (not to the fluid heater) in the event of a mains power failure. This ensures that the Smoke Screen can provide an effective activation for up to 30 minutes after a mains power failure (further detail is on the relevant Smoke Screen datasheet). The Smoke Screen is capable of activating in the event of a battery fault or if the batteries are not fitted; in the latter case, to avoid battery fault indications, the facility should be disabled (see 'Programming'). The Smoke Screen is supplied with a set of batteries and replacement batteries may be obtained from your Smoke Screen distributor or Concept Smoke Screen.

Battery protection

To prevent damage to the batteries caused by running them to a completely discharged state, the Smoke Screen will switch off the battery power 1.5 hours after a mains power failure, at which time the unit is too cold to activate; the Smoke Screen will start up normally as soon as mains power is re-applied.

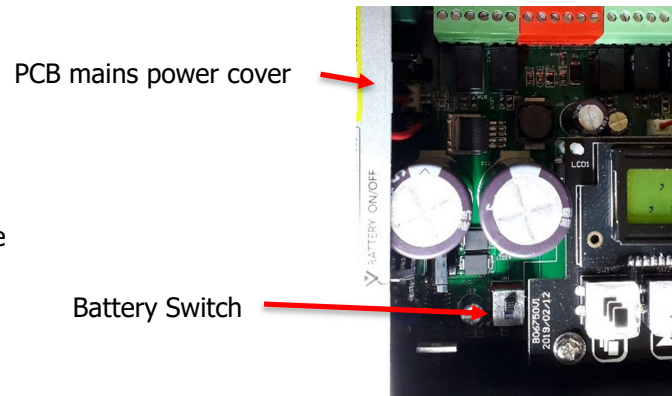

Battery switch

The Smoke Screen has a switch on the PCB to permit the batteries to be disconnected from the system whilst remaining in place (see the picture above). The delivery setting is 'Off'; select to 'On' if intending to use the battery facility.

Removal and replacement

Disconnect the mains power supply. Take off the Smoke Screen front cover, the battery compartment cover on the left side and the mains power cover on the PCB. Disconnect the battery plugs from the PCB. Slide out the old batteries, replace with new units and refit the plugs and covers

THE SMOKE SCREEN WILL NOT FUNCTION AT ALL DURING A MAINS POWER FAILURE IF THE BATTERIES ARE DISABLED.



WARNING

Be aware of high voltage in the Smoke Screen. The electrical supply should be switched off before changing the batteries.



CAUTION

If the generator has been in service, the heater block and connected parts will be extremely hot and will cause injury if touched. Switch off and allow the heater block to cool.

6.10 PROGRAMMING

Programming the Smoke Screen via the on-board LCD

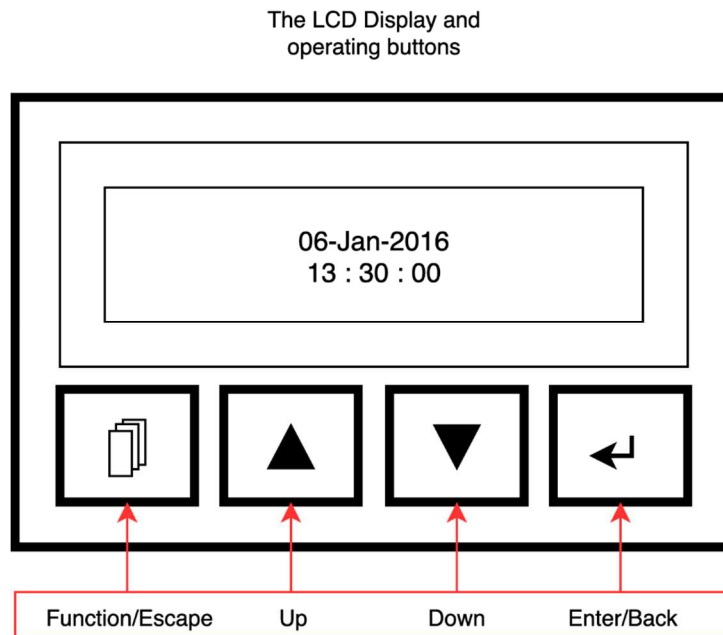

LCD illumination

Pressing any button illuminates the LCD back-light; it automatically extinguishes after 1 minute of inactivity.

Setting the time and date

In the Smoke Screen Status or Current Time display:

- Press and hold **Function/Escape** for 3 seconds until the date and time are shown with the Day flashing.
- Change the value with the **Up** and **Down** buttons.
- Press **Enter/Back** to save a change and move to the next parameter.
- Press **Function/Escape** to return to the previous parameter without saving any changes.
- Repeated presses of **Function/Escape** will return the LCD to the Live Status display.

Viewing and setting the functions and variable parameters

In the Smoke Screen Status or Current Time display:

- Press **Function/Escape** to access the programmable functions.
- Press **Up** or **Down** buttons to scroll through the available functions.
- Press **Enter/Back** to view the current function setting.
- Press **Up** or **Down** buttons to scroll through the available parameters.
- Press **Enter/Back** to select and save the value shown and return to the list of functions. (Note: if the change results in a Live Status change the display will return to the Live Status display).
- Press **Function/Escape** to return to the list of programmable functions without saving any changes.
- Repeated presses of **Function/Escape** will return the LCD to the Live Status display.

Parameter settings

MENU ITEM		DEFAULT SETTING	AVAILABLE SETTINGS	REMARKS
1	Event Log	-	Read-only.	See Section 7.2 for a list of the major events
2	Setting Smoke Time	60 seconds	0 to 360 seconds in 1 second intervals.	See Section 3.1.
3	Setting Panic Smoke Time	0 seconds	0 to 360 seconds in 1 second intervals.	See Section 3.1.
4	Invert Trigger Mode	Set, Alarm & Hold-off N/C Mode. Panic N/O Mode	N/O Mode N/C Mode	Trigger inputs can be individually set to: N/O Mode = unit detects a normally open circuit going closed to activate. N/C Mode = unit detects a normally closed circuit going open to activate. See Sections 3.1 & 6.5.
5	Enable/Disable Battery	Enable	Disable Enable	The PCB-mounted battery switch is 'Off' on delivery. See Section 6.9.
6	Enable/Disable ESM	Disable	Disable ESM Extreme	Energy Saving Mode. See Section 6.2.
7	Smoke Delay	0 seconds	0 to 60 seconds in 1 second intervals.	See Section 3.1.
	Re-triggering	Delay	Delay Instant	Available if Smoke Delay set to > 0 seconds. Select Delay to apply set Smoke Delay time to every re-trigger by the Hold-off. Instant = no delay. See Section 3.1.
8	Settle Timer	0 seconds	0 to 60 seconds in 1 second intervals.	See Section 3.1.
9	Verify Timer	0 seconds	0 to 3600 seconds in 5 second intervals.	See Section 6.3.
10	EN Mode	-	Nil.	Manufacturer-only setting.
11	Live Temperature	-	Read only.	Displays the current heater block temperature.
12	Manufacturer Setting	-	Nil.	Manufacturer-access only.
13	Send Special Command Codes	-	Nil.	Other than Command Code 1 – IP Module Restart (see Section 4) these have no function unless pre-set with Sentinel+ customer specific codes.

MENU ITEM		DEFAULT SETTING	AVAILABLE SETTINGS	REMARKS
14	SET Network	All zero	0 to 255	To set network connection addresses for use with Sentinel+. If the IP is set to '0.0.0.0' DHCP is enabled. See Section 4.
15	Reboot System	No	No Yes	Available only if 'Service Mode' active. Reboots the Smoke Screen (all settings are retained).

6.11 SENTINEL+ REGISTRATION AND REMOTE CONFIGURATION

Registration

Follow the registration link found on the Sentinel+ Self-Test Page

i.e. <http://192.168.16.84/>

Once registration is complete you will be sent a 4-digit passcode.

Local Device Status Monitoring Only

Navigate to admin page. e.g. <http://192.168.16.84/admin>

Log in using username: guest
 password: (Leave blank)

Local Device Status Monitoring and Configuration

Navigate to admin page. e.g. <http://192.168.16.84/admin>

Log in using username: installer
 password: Your 4-digit passcode

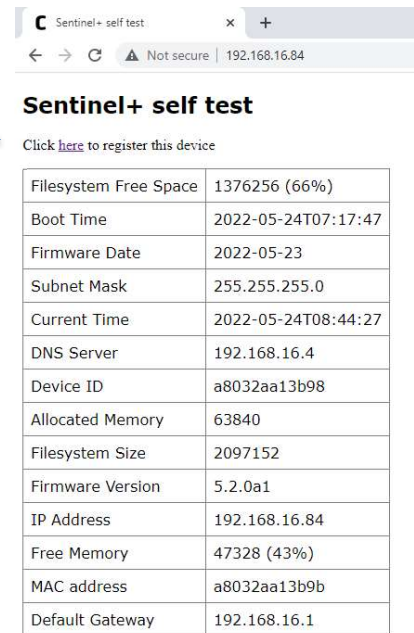

Sentinel+ self test	
Click here to register this device	
Filesystem Free Space	1376256 (66%)
Boot Time	2022-05-24T07:17:47
Firmware Date	2022-05-23
Subnet Mask	255.255.255.0
Current Time	2022-05-24T08:44:27
DNS Server	192.168.16.4
Device ID	a8032aa13b98
Allocated Memory	63840
Filesystem Size	2097152
Firmware Version	5.2.0a1
IP Address	192.168.16.84
Free Memory	47328 (43%)
MAC address	a8032aa13b9b
Default Gateway	192.168.16.1

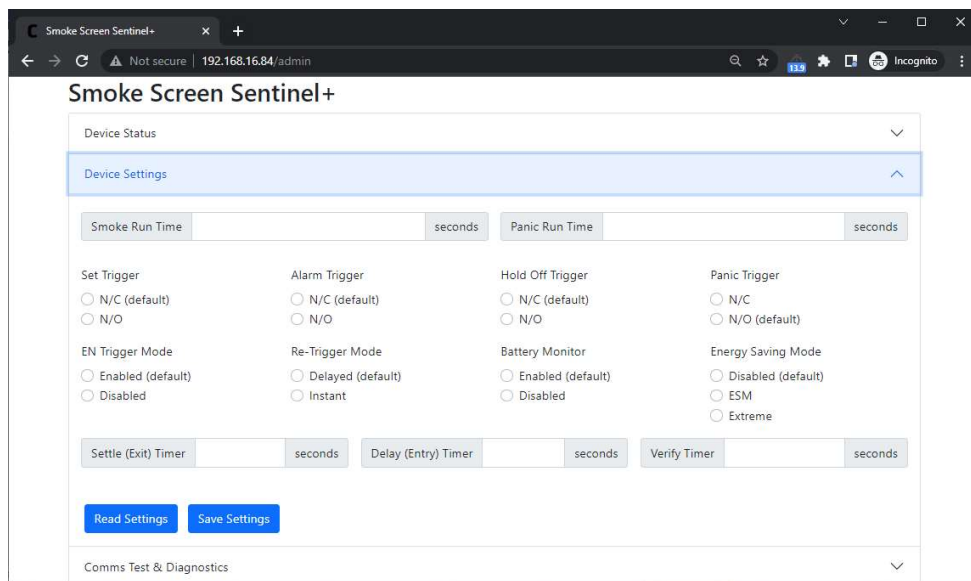

7.1 OPERATION

While the Smoke Screen is heating up the LCD display will show a 'Live Status' in code format and the LED indicator will be yellow. If the cover is open 'Tamper Fault (Ti)' will be displayed on the LCD and the LED indicator will flash yellow once every 5 seconds; a tamper indication will not, on its own, prevent the Smoke Screen from producing smoke. When the Smoke Screen reaches the correct working temperature, and a full smoke fluid consumable has been correctly installed, the LED Indicator will go Green, and the LCD Display will show the current status on the machine (see 'Codes for live status').

Stopping smoke

If the 'Hold-off' is closed during an activation the Smoke Screen will continue to produce smoke for the set Smoke Time. Once initiated an activation can be stopped only by closing the 'Alarm Set'.

Re-triggering smoke (hold-off attached)

If, after it has made smoke for the pre-set time, the Smoke Screen receives another hold-off alarm with open 'Alarm Set' and 'Trigger' inputs it will 're-trigger' and make smoke again.

7.2 TESTING

Full alarm test

Where possible a full alarm test should be conducted to check all inputs, outputs, and wiring connections to the Smoke Screen are correct. The Smoke Screen will fire for the designated 'Smoke Time' once the 'Alarm Set', 'Trigger' and 'Hold-off' (if fitted) contacts are open. It will re-trigger if the 'Alarm Set' remains open and either the 'Trigger' and/or the 'Hold-off' inputs are cycled after the set 'Smoke Time'. It will stop producing smoke if the 'Alarm Set' contacts are closed.

Panic test

Where possible a full Panic test should be conducted to check the wiring connections to the Smoke Screen are correct. The Smoke Screen will fire for the designated 'Panic Time' once the Panic input changes state.

NB: A Panic activation can be stopped before the end of the programmed smoke time only if the 'Set' is cycled to alarm and back to restore. SSI Test facility can also be used to stop panic activation. Consider testing with a short 'Panic Smoke Time' programmed, ensure changed to required time after testing.

Smoke Screen standalone test

The Smoke Screen can be tested when it is ready to operate (indicated by a green LED), and it is not in 'Service Mode' by pressing the button on the PCB marked 'PBSW1' (see the section 5.1 for the location).

NB: this does not check that the inputs and connections to the Smoke Screen are correct.

7.3 SENTINEL+ REMOTE MONITORING

Log on to Smoke Screen Sentience to claim registered Sentinel+ device

<https://sentience.smoke-screen.com/>

Follow online instructions for monitoring.

Area under construction at time of writing: Further information / examples will follow when available.

8.1 LCD LIVE STATUS INDICATIONS

The Smoke Screen provides 'Live Status' indications on the LCD to give a quick overview of the current condition of the machine. The indications have the following meanings:

Top Line (Outputs):

Indication	Meaning	Explanation
TS	Temp Status Fault	The Smoke Screen heater block is not at operating temperature, and it is not ready to activate or there is a Heater fault.
V	Verify Smoke	The Smoke Screen is active / pump running.
M	Mains Fault	The Mains Power input has failed.
B	Battery Fault	The batteries are not fitted or are switched off or there is a charging fault.
E	Empty Fluid	The Swift-Fit is empty (Smoke Screen will not produce smoke).
L	Low Fluid	The Swift-Fit fluid level is less than 50%.
TI	Tamper Internal	The Tamper Output is giving a tamper alarm.

Bottom Line (Inputs):

Indication	Meaning	Explanation
S	Set	The Set input is in an active state.
A	Alarm	The Alarm input is in an active state.
Ho	Hold-off	The Hold-off input is in an active state.
PA	Panic	The Panic input is in an active state.
Sm	Service Mode	The Service Mode Dip switch is selected on.
ES	Energy Save Mode	Energy Save Mode is enabled.



Example: The codes on the LCD screen shown above indicate the following live status:

Top line:

E, L and TI are in an alarm state - the fluid level is empty and there is a tamper.

TS, V, M and B are normal - the Smoke Screen is not making fog, the mains and battery are okay.

Bottom line:

Set and Alarm are in an alarm state and the Smoke Screen is in Service Mode.

The Hold-off and Panic are restored, and ESM is disabled.

8.2 LCD, LED, AND SOUND INDICATIONS

The Smoke Screen provides on-board status monitoring via an LCD, a multicolour LED, and a sounder. Indications displayed are:

Message	LED Colour	Buzzer Sound	Relay status change
Heating up	permanent. ●	Nil.	Nil.
System ok or Date & Time	permanent. ●	Nil.	Nil.
System SET	flash once every 5 sec. ●	Nil.	Indicates that both Set & Alarm are active. Set output gives 12v with respect to Sentinel ground.
Smoke	flash once every 1 sec ●	1 beep every 1 sec.	Verification output n/c to open.
Thermal Fault*	permanent. ●	1 long 3 short beeps every 3 mins.	TEMP. Status n/c to open.
Heater Fault*	flash once every 5 sec. ●●	1 long 2 short beep every 3 min.	TEMP. Status n/c to open.
Empty Fluid	flash once every 5 sec. ●●	1 long beep every 3 min.	Liquid Status output n/c to open. Low Fluid output n/c to open.
Low Fluid	flash once every 5 sec. ●●	1 short beep every 5 min.	Low Fluid output n/c to open.
Battery Fault	flash once every 5 sec. ●●●	3 short beep every 5 min.	Battery output n/c to open.
Tamper Fault	flash once every 5 sec. ●	2 short beep every 5 min.	Tamper Status n/c to open.
Mains Fault	flash once every 5 sec. ●	1 long 1 short beep every 3 min.	Mains Fail output n/c to open. TEMP. Status n/c to open.
Service Mode Setting	alternate flash. ●●	Nil.	Tamper Status n/c to open.

Notes:

- The LCD will display the current status via the on-board codes for Live Status.
- Once resolved, fault indications will automatically clear, except those marked * that also require the removal and restoration of mains and battery power or a reboot via the menu.

8.3 THERMAL CUT-OUT (TCO) RESET



Be aware of high voltage in the block area. The electrical supply should be switched off before working in the heater block compartment.



This operation is usually carried out during installation. If the Smoke Screen has been in service, the nozzles will be extremely hot and will cause injury if touched. Therefore, the Smoke Screen should be switched off and time should be allowed for the nozzles to cool.

In the unlikely event that the temperature in the heater block increases significantly above the set working temperature the TCO will trip to protect the machine from damage. The TCO can be reset using the following procedure:

- Make sure mains and battery power to the machine is turned off before resetting the TCO.
- Reset the TCO by pressing on the little button on the top area that is accessed through the hole in protective cover (see photo below). If the thermal device has tripped it should be possible to hear a click when it resets.
- Switch on the mains power after resetting, then turn on batteries.
- Check the machine heats up to normal operating temperature and make sure it archives a ready state. See the operating 'LCD, LED, and Sound Indications' for further information on fault indications.

NB: A TCO usually only trips if there is a problem. If it trips again the Smoke Screen should be checked for faults before further use. Monitor Live Temperature display for abnormalities.

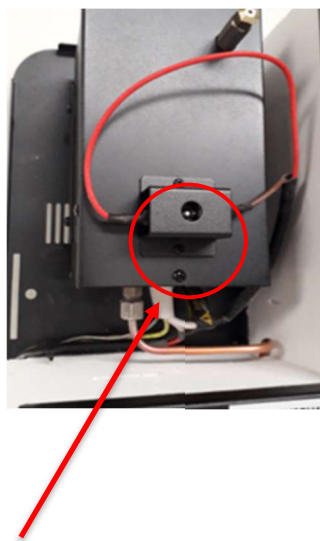

Note: The position of the TCO can be different depending on the machine version

8.4 ACTION AFTER EVERY ACTIVATION

- Wait until the smoke production has ceased. **Do not try to enter the affected area as you will not be able to see through the fog.**
- Look for signs of forced entry. If you find any, or you believe that intruders are on the premises, call the Police and wait for them to arrive. **Take no further action.**
- Where there are no signs of forced entry, open all external doors and wait for the fog to start clearing – this may take 10 to 15 minutes. Keep watch for intruders that may have been screened by the fog.
- As visibility returns open more doors or windows to speed up the venting process.
- Check the fluid level for the Smoke Screen by checking the appropriate LEDs as described above. It is recommended that the installer or Concept Smoke Screen are requested to service/replenish the Smoke Screen if there have been 2 or more activations of the Smoke Screen.

8.5 SERVICING AND CONSUMABLE REPLENISHMENT

Installation/service engineer qualification. Please note that it is a requirement of the standards relating to security fogging devices that the Smoke Screen is serviced/replenished by an engineer certified as competent by the manufacturer. If you are unsure, ask the engineer for their certification ID card.

Smoke Screen servicing. To ensure the Smoke Screen remains fully operational it must be regularly serviced by a Concept Smoke Screen certified engineer. Failure to service the Smoke Screen may invalidate the warranty.

Service intervals. The Smoke Screen should be serviced annually by a Concept Smoke Screen certified as competent engineer and the following consumables should be replaced as specified:

Fluid: Always ensure that the Smoke Screen has sufficient fluid, or it will not produce smoke when needed. The fluid consumable should be changed:

- Every 12 months as 'best-practice' or, as a minimum, every 2 years.
- If the Smoke Screen displays a Low or Empty Fluid fault in between services.
- If there have been 2 or more activations of the Smoke Screen since the fluid was replenished.

WARNING: Only Smoke Screen fluid should be used as other smoke fluids may cause damage to the unit or noxious fumes.

Batteries: The batteries should be changed:

- At least every 2 years.
- If the Smoke Screen displays a battery fault in between services.

WARNING: Only batteries supplied by Concept Smoke Screen should be used in the Smoke Screen.

Note: It is recommended that a test activation of the Smoke Screen system for at least 10 seconds is performed every 3 - 6 months

9.1 GLOSSARY

Item	Meaning	Explanation
Alarm	Smoke Screen alert input	Signal from Alarm panel or SSI to Smoke Screen
Activation	Smoke Screen making fog	
Dip switch	PCB mounted on/off switch	
Drop-in anchor	M8 fixing for blind holes in masonry	
ESM	Energy Saving Mode	A slight reduction in running temperature when 'Unset' that reduces the power consumption
Hold-off	Final trigger before activation	PIR or another device such as a door contact
Invert Trigger Mode	Changes the alarm input requirement between n/o and n/c	
Live Status	The current status of the Smoke Screen	Faults, inputs, and settings shown on the LCD (see Section 7.1)
n/c	Normally closed	Output status
n/o	Normally open	Output status
Panic	A single input that will activate fog.	
Panic Time	Time set for a panic activation	
PB SW1	Push Button switch	PCB mounted activation test switches
PIR	Passive InfraRed	Motion detector
Screen Sensor	A device that can be used to maintain a fog density after an activation	
Set	Smoke Screen Alarm / Disarm input	Signal from Alarm Panel or SSI to Smoke Screen
SM	Service Mode	Smoke Screen is isolated for repair/installation
Sentinel+	Sentinel Smoke Screen with IP capability	
Settle Timer	Time after the Smoke Screen is Set during which it will not react to a Hold-off input	Use for PIR settling time on exit
Smoke	Fog	The Smoke Screen makes a fog rather than produces smoke
Smoke Delay	Time after an activation demand before the Smoke Screen activates	
Smoke Mode	Setting that varies the intensity of the initial burst of smoke	
Smoke Time	Time set for each activation	
SSI	Smoke Screen Interface	Isolating key-switch with status indications
TCO	Thermal Cut Out	Mechanical safety trip in case of heater block overheat
Temp Status	The Smoke Screen block temperature	Indication if the Smoke Screen is at operating temperature (see 'Live Status' at Section 7.1)
Thermocouple	Temperature sensor	Gives the heater block temperature to the PCB
Trigger	One of the activation conditions of the Smoke Screen	
Unistrut	Metal suspension bracket	
Unset	Smoke Screen not in operation	Signal from Alarm Panel or SSI to Smoke Screen
Verification	Output indication of an activation	Smoke Screen making fog
Verify Timer	Time that the verification output maintains a change of state after an activation is initiated	
WEEE	Waste Electrical and Electronic Equipment	

9.2 FAQ

Q **The Smoke Screen is indicating it is ready to operate but does not respond to a full alarm test.**

A Ensure 'Service Mode' is disabled.

With power applied, and keeping clear of the smoke nozzle, disconnect the 'Alarm' / 'Trigger' and 'Hold-off' connection plugs from the PCB. If the Smoke Screen produces smoke, there is a misconnection in the system wiring.

Q **The Smoke Screen is puffing out smoke whilst heating up.**

A This is the result of very small amounts of air and residual fluid in the heater block being changed into an insignificant volume of smoke and can happen particularly after the Smoke Screen has been moved about when cold, i.e., prior to installation or in the time after an activation.

9.3 END OF PRODUCT LIFE POLICY

At Concept Smoke Screen we take our environmental obligations very seriously and constantly strive to minimise any environmental impact of the products we sell.

To comply with the WEEE Regulations 2013 we label all relevant products with the crossed-out wheelie bin symbol and are members of the Comply Direct WEEE compliance scheme. Comply Direct have registered us with the Environment Agency as a Producer and will arrange to have any of our equipment collected and recycled as necessary. Comply Direct can be contacted on 0844 873 1034. If arranging a collection, please quote our membership number which is CD01/00593. Our Environment Agency Producer Registration number is WEE/HB3530XZ.

How to return goods

When the goods are no longer required or are deemed to be beyond economic repair you can also return the goods to the following address for disposal:

Smoke Screen, 1C North End Business Park, Station Road, Swineshead, Lincolnshire, PE20 3PW

Alternatively, if it is more convenient to arrange disposal locally, please ensure disposal is carried out in accordance with any local guidelines.

Further guidance can be found here <https://www.complydirect.com/the-recycling-room/>

9.4 WARRANTY TERMS AND CONDITIONS

CSS Return to Base warranty service may be obtained only against presentation of the following information:

- (a) the purchase date.
- (b) the invoice number.
- (c) the model's name and serial number of the purchased product.
- (d) the date of installation of the product.
- (e) full details of the nature of the fault.
- (f) copies of any service records.

CSS reserves the right to refuse warranty service if this information is not complete.

CSS may repair or replace CSS products with new or reconditioned parts or products of equivalent to new performance and reliability. CSS may also replace products with equivalent models where the original has been discontinued. Reconditioned parts or products will only be used if it is permissible to do so under the statutory law of a country where the warranty is applied

Warranty period

This warranty is valid from the date of purchase, as evidenced by the above-mentioned documents, for the following periods:

- Sentinel (All variants including Titanium), Strobe and Sounder:
 - 12 months parts and labour plus an additional 24-month parts only.

Limitations

CSS do not warrant the following:

- Periodic check-ups, maintenance and repair or replacement of parts due to normal wear and tear.
- Consumables.
- Any software.
- Defects caused by modifications carried out without CSS's approval.
- Costs incurred by CSS in making any adaptations or modifications of a product necessary for country specific technical or safety standards or specifications, or any other costs to adjust the product as a result of any specifications which have changed since the delivery of the product.
- Damage resulting from the fact that a product is not conforming to country specific standards or specifications in another country than the country of purchase.

Warranty repair service is excluded if the equipment has not been serviced on, as a minimum, an annual basis and if damage or defects have been caused by:

- Improper use, excessive use, handling, or operation of the product including without limitation, incorrect storage, dropping, excessive shocks.
- Repairs, modifications, or cleaning carried out at a service centre not authorised by CSS.
- Damage caused directly by the use of spare parts, software or consumables which are not compatible with the product.
- Inadequate packaging of the product when returning it to the CSS Repair Centre.
- Accidents or disasters or any cause beyond the control of CSS, including but not limited to lightning, water, fire, public disturbances, and improper ventilation.

To obtain a warranty service

Warranty service is available from CSS UK Head Office. Any costs of secure transportation of the product to and from CSS will be borne by the customer.

Where an Installer chooses to replace a part themselves, the supply of the replacement part will become chargeable should the faulty item not be returned to CSS within 21 days of receipt of said replacement part.

Other information

When returning the product for warranty service, please pack it very carefully and enclose the instructions for repair. CSS shall not be liable for any incidental or consequential damages for breach of any express or implied warranty of this product.

These warranty terms and conditions are offered to you by CSS without prejudice to any statutory rights that you may additionally have with regard to the products covered by these terms and conditions.

Installer Notes

SENTINEL S55 v7 v1.2 (July 2022)

SMOKE SCREEN

1C North End Business Park, Station Rd, Swineshead, Lincolnshire, PE20 3PW United Kingdom
Tel: +44 (0) 1205 821111 | info@smoke-screen.co.uk | www.smoke-screen.com